

## Socket For Interface Relay

## P2RF

**A slim, space-efficient Socket with max. width of 16 mm.**

- Designed for G2R and G3R PC Board Relays
- Conforms to UL and CSA standards.
- Separate inputs and outputs for superior insulation- and efficient wiring.
- Convenient snap-in mounting system for easy attachment and removal on DIN rail track.

## Ordering Information

Model	No. of pins
P2RF-05-E	5
P2RF-08-E	8

### ■ Accessories (Order Separately)

Item		Model
Mounting Track	DIN rail (length: 50 cm)	PFP-50N
	DIN rail (length: 100 cm)	PFP-100N/PFP-100N2
End Plate		PFP-M
Spacer		PFP-S

## Dimensions

**Note:** All units are in millimeters unless otherwise indicated.

**Track/Surface Mounting Sockets**  
**P2RF-05-E**

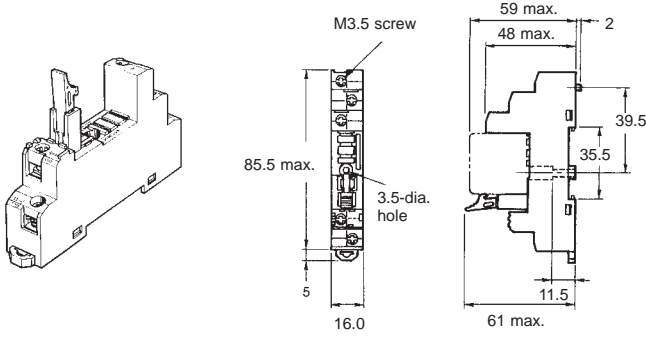

**Terminal Arrangement (Top View)**

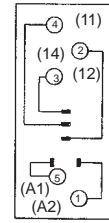

**Mounting Holes (for Surface Mounting)**

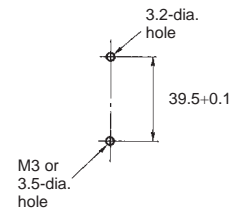

**Note:** Pin numbers in parentheses apply to DIN standard.

**P2RF-08-E**

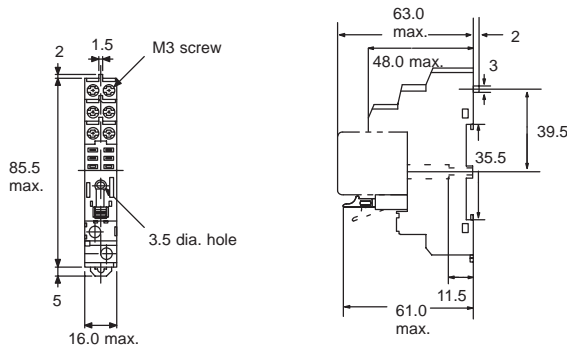

**Terminal Arrangement (Top View)**

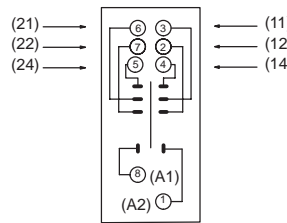

**Mounting Holes (for Surface Mounting)**

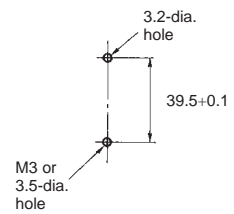

**Mounting Track (Order Separately)**  
**PFP-100N, PFP-50N**  
(conforming to DIN EN 50022)

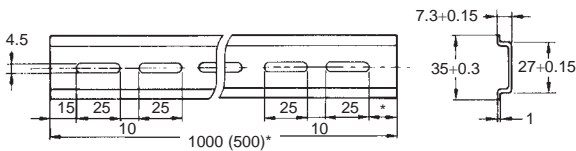

**PFP-100N2**  
(conforming to DIN EN 50022)

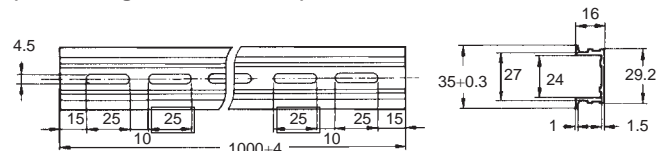

\* This dimension applies to Mounting Track PFP-50N

**Applicable Relays**

Socket model	Applicable relays	
	Electromagnetic relays	Solid-state relays
P2RF-05-E	G2R-1-S(N)(A)(NA)	G3R-202SN-US-E G3R-202SLN-US-E G3RD-X02SN-US-E
P2RF-08-E	G2R-2-S(S)(A)(NA)	-

**UL/CSA Standards**

Model	UL File No.	CSA File No.
P2RF-05-E	E87929	LR31928
P2RF-08-E	E87929	LR31928

**ALL DIMENSIONS SHOWN ARE IN MILLIMETERS.**

To convert millimeters into inches, multiply by 0.03937. To convert grams into ounces, multiply by 0.03527.

Cat. No. Q04-E1-3A **In the interest of product improvement, specifications are subject to change without notice.**

## **OMRON Corporation**

Relay Division  
29th Fl., Crystal Tower Bldg.  
1-2-27, Shiromi, Chuo-ku,  
Osaka 540 Japan  
Phone: 06-949-6125  
06-949-6134

Fax:

Printed in Japan  
1191-1M (0391)