

Zoccolo per montaggio frontale/guida DIN

P2RF-05-S

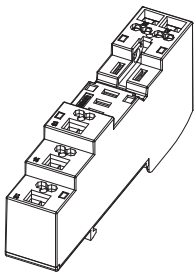

Modello standard

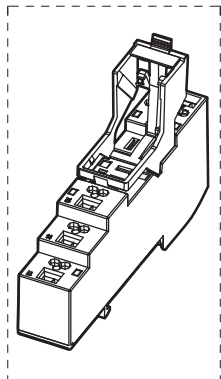

Opzione (con leva di fissaggio/ sgancio e targhetta)

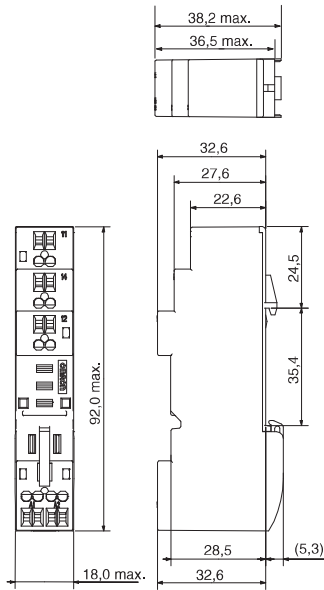

Disposizione terminali (vista dall'alto)

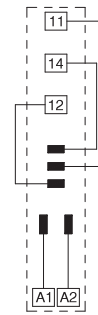

P2RF-08-S

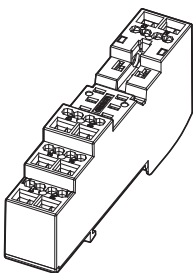

Modello standard

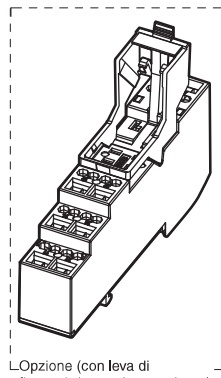

Opzione (con leva di fissaggio/ sgancio e targhetta)

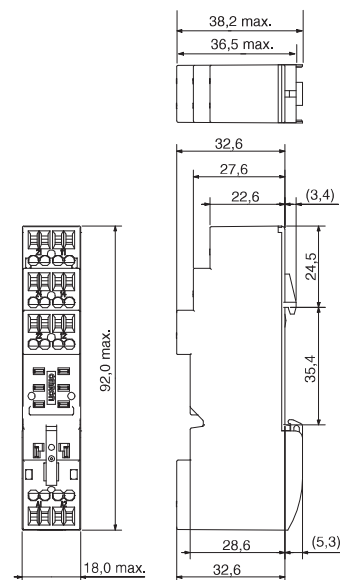

Disposizione terminali (vista dall'alto)

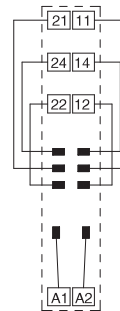

Accessori per P2RF-□-S

Ponticello con rivestimento isolante

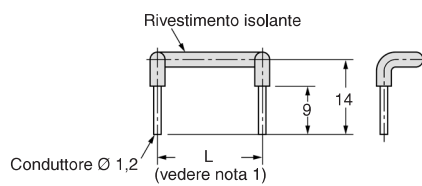

Leva fissaggio/sgancio

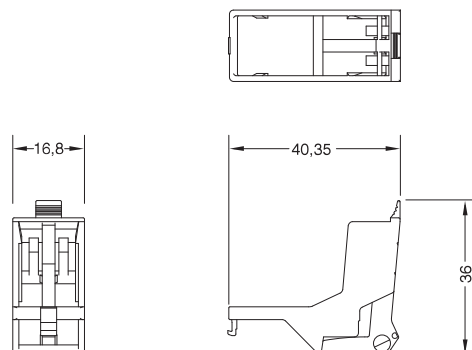

P2RF-05-E

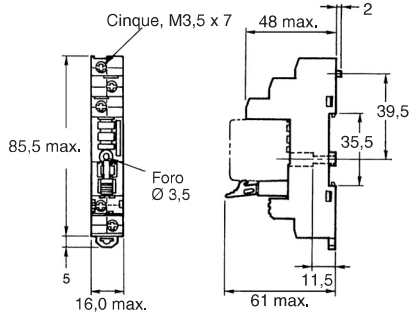
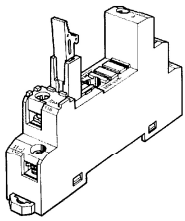

Disposizione terminali (vista dall'alto)

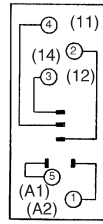

Fori di montaggio (per montaggio su superficie)

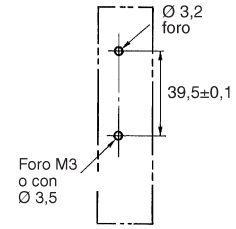

Nota: I numeri di pin tra parentesi si riferiscono allo standard DIN.

P2RF-08-E

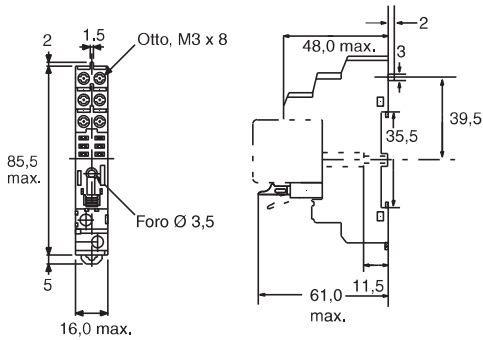
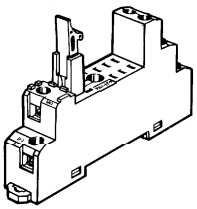

Disposizione terminali (vista dall'alto)

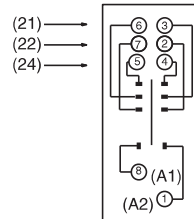

Fori di montaggio (per montaggio su superficie)

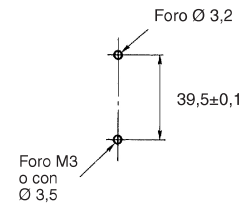

P2RF-05

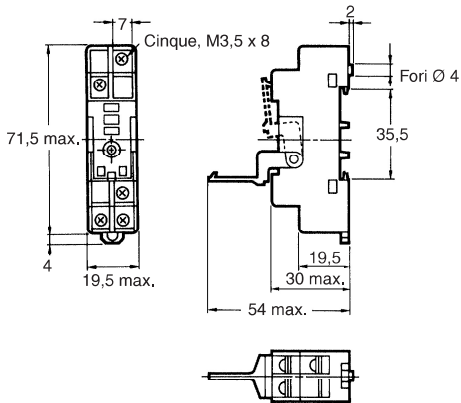
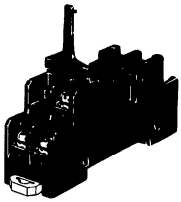

Disposizione terminali (vista dall'alto)

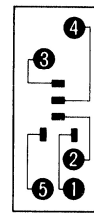

Fori di montaggio (per montaggio su superficie)

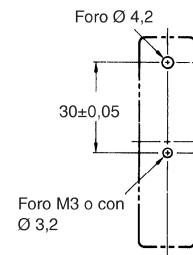

P2RF-08

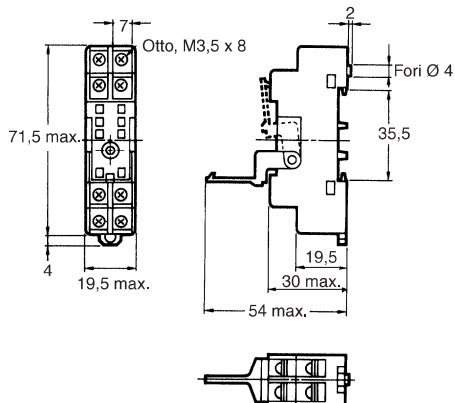
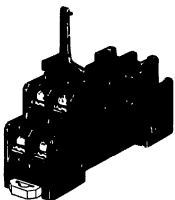

Disposizione terminali (vista dall'alto)

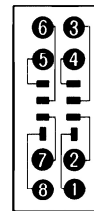

Fori di montaggio (per montaggio su superficie)

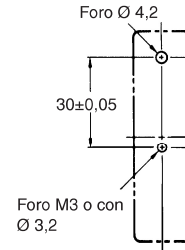

Altezza di montaggio con zoccoli per montaggio frontequadro/guida DIN

P2RF-□

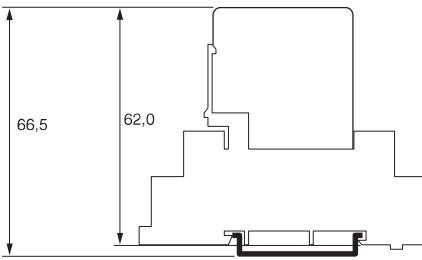

P2RF-□-E

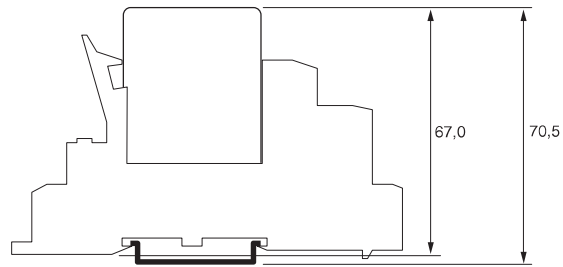

P2RF-□-S

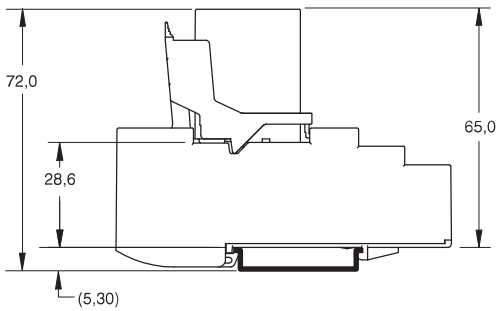

Zoccoli per montaggio retroquadro

P2R-05P (unipolare)

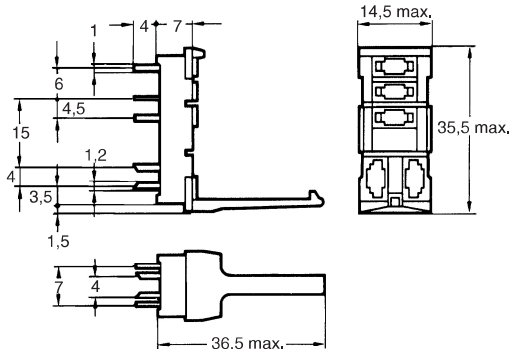
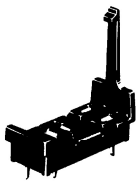

Disposizione terminali (vista dal basso)

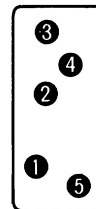

Fori di montaggio

Tolleranza: $\pm 0,1$

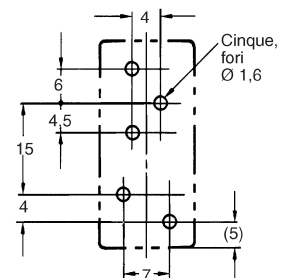

P2R-08P (bipolare)

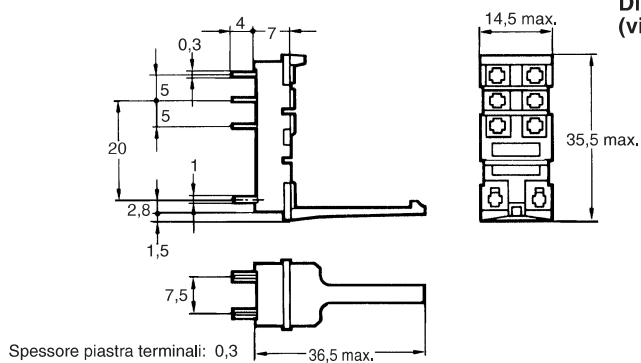
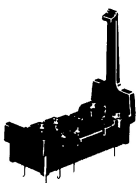

Disposizione terminali (vista dal basso)

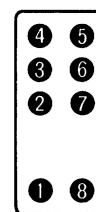

Fori di montaggio

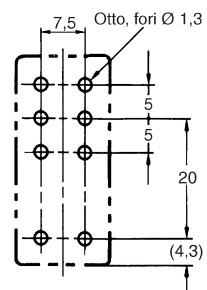

P2R-05A (bipolare)

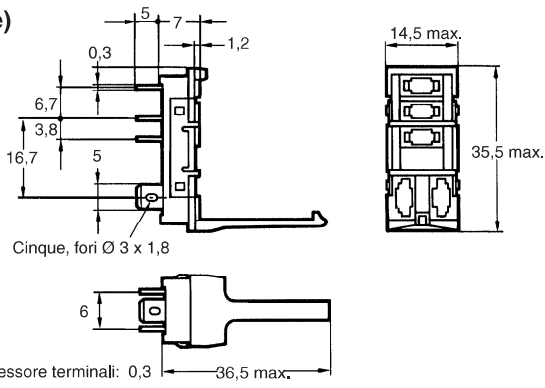
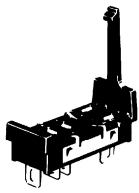

Disposizione terminali (vista dal basso)

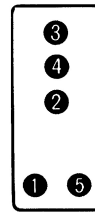

Fori mascherina

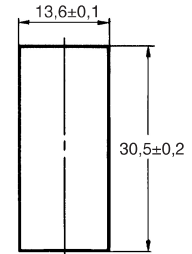

Lo spessore del pannello raccomandato è: 1,6...2,0

P2R-08A (bipolare)

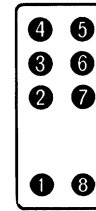
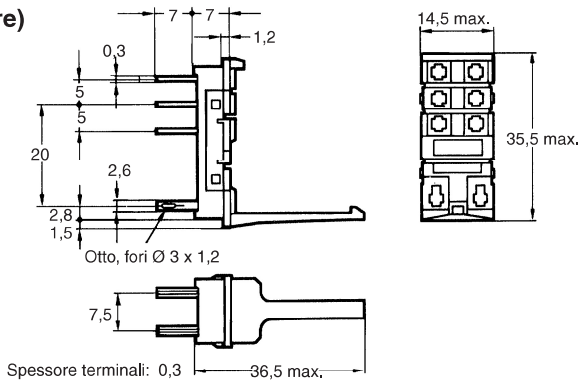
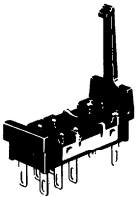

P2R-057P

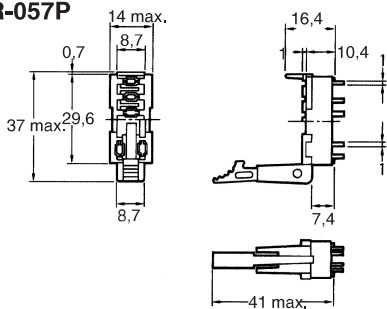

Disposizione terminali (vista dal basso)

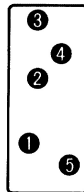

Fori di montaggio

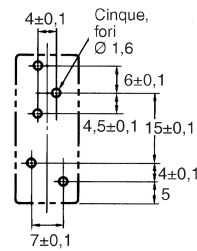

P2R-087P

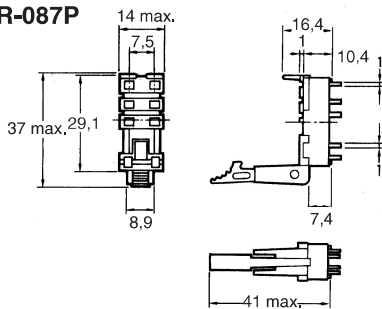

Disposizione terminali (vista dal basso)

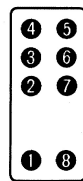

Fori di montaggio

