



User Manual

TSOL-M350

TSOL-M400

TSOL-M800

TSOL-M1600

Trademarks and Permissions

 and other TSUNESS trademarks are trademarks of TSUNESS Co., Ltd All other trademarks and trade names mentioned in this document are the property of their respective holders.

TSUNESS Co., Ltd makes no representations, express or implied, with respect to this documentation or any of the equipment and / or software it may describe, including (with no limitation) any implied warranties of utility, merchantability, or fitness for any particular purpose.

All such warranties are expressly disclaimed. Neither TSUNESS nor its distributors or dealers shall be liable for any indirect, incidental, or consequential damages under any circumstances. (The exclusion of implied warranties may not apply in all cases under some statutes, and thus the above exclusion may not apply.)

Specifications are subject to change without notice. Every attempt has been made to make this document complete, accurate and up-to-date. Readers are cautioned, however, that TSUNESS reserves the right to make changes without notice and shall not be responsible for any damages, including indirect, incidental or consequential damages, caused by reliance on the material presented, including, but not limited to, omissions, typographical errors, arithmetical errors or listing errors in the content material.

All trademarks are recognized even if these are not marked separately. Missing designations do not mean that a product or brand is not a registered trademark. All trademarks are recognized as the property of their respective owners.

Product information is subject to change without notice. User documentation is updated frequently; Check www.tsun-ess.com for the latest information. To ensure optimal reliability and to meet warranty requirements, the TSUNESS-Microinverter must be installed according to the instructions in this manual. For warranty text refer to www.tsun-ess.com.

© 2018 TSUNESS Co., Ltd All rights reserved.

Audience

This manual is intended for use by professional installation and maintenance personnel.



CONTENT

Read This First	1
Important Safety Information	1
Product Label	2
Warning	3
System Introduction	4
Product Description	5
Installation of Micro Inverter	7
Check Installation Environment	7
Installation Position	8
Step 1. Make an Installation Map	8
Step 2. Install Micro Inverter	9
Step 3. Connect AC Cable	10
Step 4. Connect AC End Cable	12
Step 5. Connect PV Module	15
Step 6. Start the System	16
Maintenance Guide	17
Routine Maintenance	17
Storage and Dismantling	18
Warranty	19
Exclusions	19
Distributor Responsibility	20
Miscellaneous	21
Contact	21



Read This First

Dear customer, thank you for choosing the TSOL micro inverter from TSUNESS. We hope you will find our products meet your needs for renewable energy. Meantime, we appreciate your feedback regarding our products.

A solar micro inverter, or simply micro inverter, is a plug-and-play device used in photovoltaics, that converts direct current (DC) generated by a single solar module to alternating current (AC). The main advantage is that small amounts of shading, debris or snow lines on any single solar module, or even a complete module failure, do not disproportionately reduce the output of the entire array. Each micro inverter harvests optimum power by performing maximum power point tracking (MPPT) for its connected module. Simplicity in system design, lower amperage wires, simplified stock management, and added safety are other factors introduced with the micro inverter solution.



This manual contains important instructions for TSOL-M350/400/800/1600 micro inverters and must be read in its entirety before installing or commissioning the equipment. For safety, only qualified technicians, who have received training or have demonstrated skills can install and maintain this micro inverter under the guide of this document.

Important Safety Information







During installation, testing and inspection, adherence to all the handling and safety instructions is mandatory. Failure to do so may result in injury or loss of life and damage to the equipment.

Product Label

The following safety symbols are used in this document. Familiarise yourself with the symbols and their meaning before installing or operating the system.





Symbol	Usage
 DANGER	Indicates a hazardous situation that can result in deadly electric shock hazards, other serious physical injury, or fire hazards.
 WARNING	Indicates directions which must be fully understood and followed in their entirety in order to avoid potential safety hazards including equipment damage or personal injury.
 CAUTION	This points out that the described operation must not be carried out. The reader should stop, use caution and fully understand the operations explained before proceeding.

The symbols on the micro-inverter are listed below and illustrated in detail.

Symbol	Usage
 TREATMENT	To comply with European Directive 2012/19/EU on waste Electrical and Electronic Equipment and its implementation as national law, electrical equipment that has reached the end of its life must be collected separately and returned to an approved recycling facility. Any device no longer required must be returned to an authorized dealer or approved collection and recycling facility.
 CAUTION	Do not come within 8 inches (20cm) of the micro-inverter for any length of time while it is in operation.
 DANGER OF HIGH VOLTAGES	Danger to life due to high voltage in the micro inverter.
 BEWARE OF HOT SURFACE	The inverter can become hot during operation. Avoid contact with metal surfaces during operation.
 CE MARK	The inverter complies with the requirements of the Low Voltage Directive for the European Union.
 READ MANUAL FIRST	Please read the installation manual first before installation, operation and maintenance.

Warning

- ❗ Only qualified personnel should install, troubleshoot, or replace TSOL micro inverters or the cable and accessories.
- ❗ Before installation, check the unit to ensure absence of any transport or handling damage, which could affect insulation integrity or safety clearances. Choose installation location carefully and adhere to specified cooling requirements. Unauthorized removal of necessary protections, improper use, incorrect installation and operation may lead to serious safety and shock hazards or equipment damage.
- ❗ Ensure that all AC and DC are correctly wired and that none of the wires are pinched or damaged.
- ❗ When the photovoltaic array is exposed to light, it supplies a DC voltage to the inverter.
- ❗ Do not install the equipment in adverse environment conditions such as flammable, explosive, corrosive, extreme high or low temperature, and humid. Do not use the equipment when the safety devices do not work or are disabled.
- ❗ Be aware that installation of this equipment includes risk of electric shock. Do not install the AC junction box without first removing AC power from the system.
- ❗ Do not connect micro-inverters to the grid or energize the AC circuit(s) until you have completed all of the installation procedures and have received prior approval from the electrical utility company. Only qualified personnel should connect this system to the utility grid.
- ❗ The DC conductors of this photovoltaic system are ungrounded and may be energized.
- ❗ Always de-energize the AC branch circuit before servicing. Never disconnect the DC connectors under load.
- ❗ Do not use the equipment if any operating anomalies are found. Avoid temporary repairs.

-  All repairs should be carried out using only approved spare parts, which must be installed in accordance with their intended use and by a licensed contractor or authorized TSUNESS service representative. Tampering with or opening the TSOL micro inverter will void the warranty.
-  The TSOL micro inverter is not protected from damage due to moisture trapped in cabling systems. Never mate micro-inverters to cables that have been left disconnected and exposed to wet conditions. This voids the TSUNESS warranty.
-  The maximum open circuit voltage of the PV module must not exceed the specified maximum input DC voltage of the TSOL micro inverter.
-  You must match the DC operating voltage range of the PV module with the allowable input voltage range of the TSOL micro-inverter.
-  Make sure protective sealing caps have been installed on all unused AC connectors. Unused AC connectors are live when the system is energized by the grid. Do not reuse sealing caps.

System Introduction

The TSOL-M350/M400/M800/M1600 micro inverter is used in grid-tied applications, comprised of three key elements:

- T** TSOL-M350/M400/M800/M1600 Micro inverter.
- T** Talent-MG2 Micro inverter Monitor Device.
- T** Talent web-based monitoring and analysis system.

*More information can be found in the document Talent-MG2 Monitoring System User Manual.

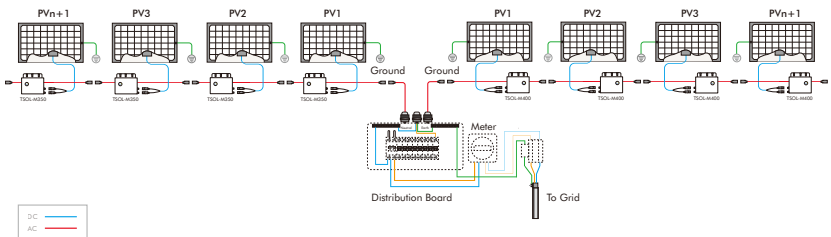

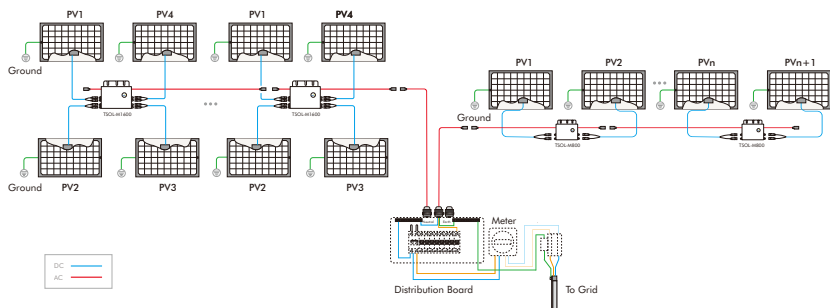

Product Description

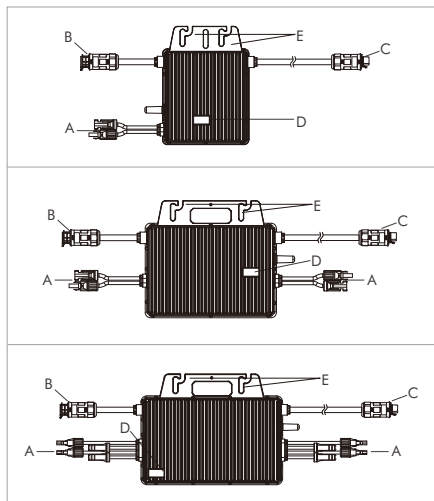

Item	Description
A	DC connectors
B	Female AC Connector
C	Male AC Connector
D	LED
E	Mounting Hole

*More information can be found in the document TSOL-M Series Micro inverter Accessories Instruction.

Model	TSOL-M350	TSOL-M400	TSOL-M800	TSOL-M1600
Input Data (DC)				
Recommended Input Power (W)	240~380	280~440	2 * 280~440	4 * 300~470
Mppt Voltage Range (V)	32~48	33~48	33~48	36~48
Operating Voltage Range (V)	16~60			
Max. Input Voltage (V)	60			
Max. Input Current (A)	10.5	11.5		
Max. Input Short Circuit Current (A)	15			
Output Data (AC)				
Max. Continuous Output Power (W)	300	350	700	1500
Nominal Output Current (A)	1.3	1.52	3.04	6.52
Nominal Output Current (A)	1.45	1.59	3.19	6.82
Nominal Output Voltage (V)	220/230/240 , L/N/PE			
Nominal Frequency (Hz)	50/60			
Power Factor	>0.99			
Output Current Harmonic Distortion	<3%			
Maximum Units Per 20A Branch	18	16	7	3
Efficiency				
Peak Inverter Efficiency	96.7%	96.7%	96.7%	96.7%
CEC Weighted Efficiency	96.5%	96.5%	96.5%	96.5%
Nominal Mppt Efficiency	99.9%	99.9%	99.9%	99.9%
Night Time Power Consumption (mW)	<50			
Mechanical Data				
Dimensions (W×H×D mm)	178 x 153 x 28	178 x 153 x 28	250 x 170 x 28	280 x 176 x 33
Weight [kg]	1.98	1.98	3	3.75
Type of Enclosure	IP 67			
Cooling	Natural Convection			
Environmental Data				
Ambient Temperature Range	-40°C to 65°C			
Internal Temperature Range	-40°C to 85°C			
Relative Humidity	0-100 % condensing			
Max. Altitude Without Derating [m]	2000			
Monitor	2.4G RF			
Max Transmitting Power	5.68 dBm			
Frequency Band	2403MHz, 2423MHz, 2440MHz, 2461MHz, 2475MHz			

※ The AC voltage and frequency range may vary depending on specific country grid. try grid.



Installation of Micro Inverter

WARNING: BEFORE INSTALLATION, CHECK THE UNIT TO ENSURE ABSENCE OF ANY TRANSPORT OR HANDLING DAMAGE, WHICH COULD AFFECT INSULATION INTEGRITY OR SAFETY CLEARANCES.

Check Installation Environment

Choose installation location carefully and adhere to specified cooling requirements. Unauthorized removal of necessary protections, improper use, incorrect installation and operation may lead to serious safety and shock hazards or equipment damage.

The installation must be carried out with the equipment disconnected from the grid (power disconnect switch open) and with the photovoltaic modules shaded or isolated.

To avoid unwanted power derating due to an increase in the internal temperature of the inverter, do not expose it to direct sunlight.

To avoid overheating, always make sure the flow of air around the inverter is not blocked.

Do not install in places where gasses or flammable substances may be present.

Avoid electromagnetic interference that can compromise the correct operation of electronic equipment.

For the safety of personnel and equipment, make sure the PV array is connected and grounded with other conductor casing.

Installation Position

When choosing the position of installation, comply with the following conditions:

Install only on structures specifically designed for photovoltaic modules (supplied by installation technicians).

Install micro inverter underneath the photovoltaic modules so that they work in the shade. If this condition cannot be met, the inverter could undergo derating.

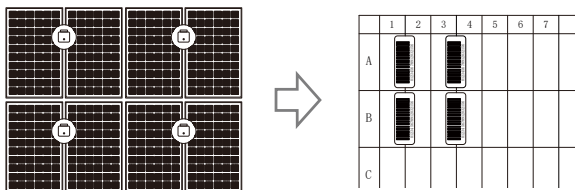

Figure The installation map (TSOL-M800)

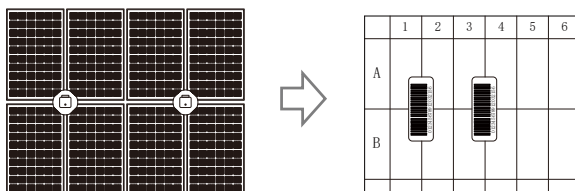

Figure The installation map (TSOL-M1600)

CAUTION

In order to provide a better after-sale service, please make the installation map carefully and keep the drawing in good condition.

Step 2. Install micro-inverter

Mark the approximate center of PV module on the frame and install the micro-inverter with the LED side facing outside.

CAUTION

The distance between every two micro-inverters should meet the length of AC cables. The length of AC cables are shown as below:

Model	Length
TSOL-M350/400	1.25m
TSOL-M800/1600	2.08m

**WARNING**

Micro-inverter should be installed in a suitable position with good ventilation and no directly sunshine.

Using two pairs of screws and nuts to fix the bracket holes of the micro-inverter onto the frame.

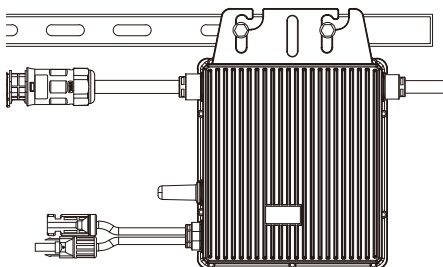

Figure Installation example

**CAUTION**

There are no screws and nuts in the package.

Step 3. Connect AC cable

Every micro-inverter could be connected to the other one by its AC cables.

**CAUTION**

According to the max current of the AC cables, there is a max installation quantity for the micro-inverter in each cable section.

Model	Quantities for each cable section
TSOL-M350	18 pcs
TSOL-M400	16 pcs
TSOL-M800	7 pcs
TSOL-M1600	3 pcs

Plug the female AC connector of one microinverter into a male AC connector of another micro-inverter to form a continuous AC branch circuit.

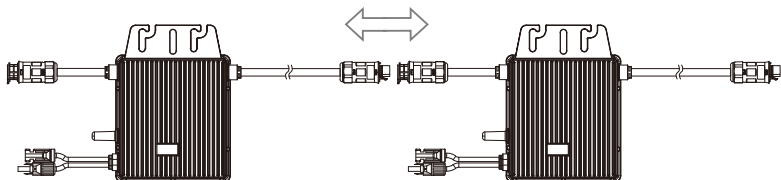

Figure Connect the AC cable

Use Nylon cable ties to fix the AC cables onto the frame.

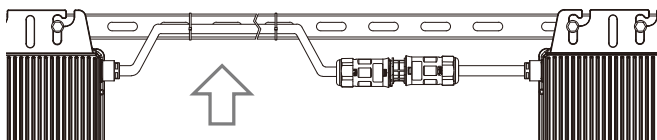

Figure Fix the AC cables



CAUTION

If the AC cable is too short for installation, use an Interconnection Cable (TSOL-MC200-G2, 2m) to connect two TSOL-M1600 which are installed in one line or two TSOL-M350/400 which are installed in two different lines.

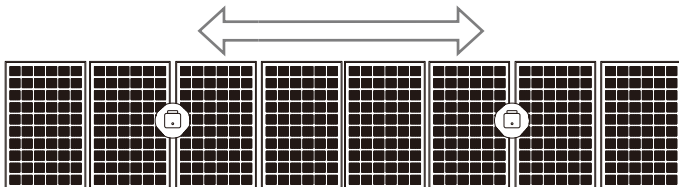

Figure TSOL-M1600 installed in one line

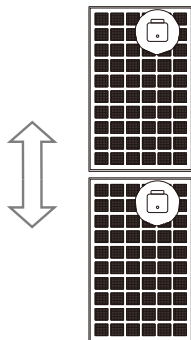

Figure TSOL-M350/400 installed in two different lines

**WARNING**

Use a Connector Protective Cap (TSOL-MP-F/M) to make sure the unused AC connector to be closed.

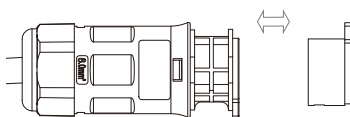

Figure Connector Protective Cap

Step 4. Connect AC end cable

Separate the AC connector as shown below.

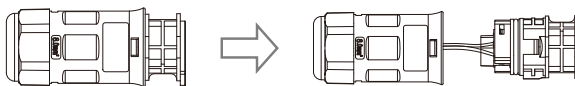

Figure Separate the AC connector

Connect the cable to the right port of the connector. The definition of the port is shown below:

L: Live (Brown/Red)
 N: Neutral (Blue/Black)
 PE: Ground (Yellow-Green)

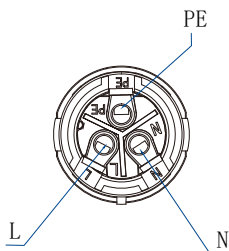

Figure Definition of the port

If the micro-inverter is connected to 110/220 V or 115/230V or 120/240V two-phase split power grid, connect two live lines to port L and port N.

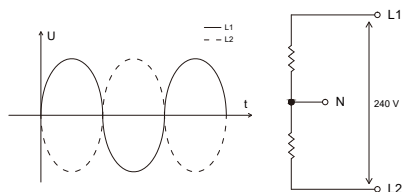

Figure Two-phase split power grid and connection of each port

If the micro-inverter is connected to 220/380 V or 230/400V or 240/415V three-phase WYE power grid, connect the live line to port L and connect the neutral line to port N, as the connection of single-phase power grid.

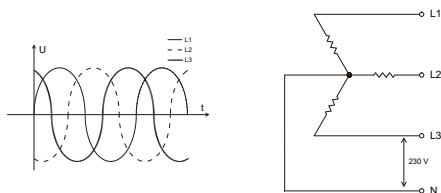

Figure 230/400V three-phase WYE power grid and connection of each port

If the micro-inverter is connected to 127/220 V or 120/208V three-phase WYE power grid, connect one live line to port L and connect another live line to port N.

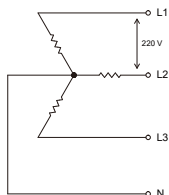

Figure 127/220V three-phase WYE power grid and connection of each port



WARNING Use AWG 12 (4 mm²) cable for AC end cable.



DANGER Make sure each cable is connected to the right port.

Reassemble the AC connector as shown below.

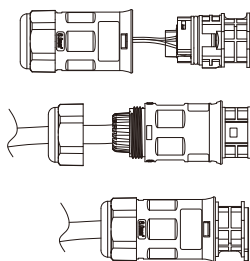

Figure Reassemble the AC connector

Plug the AC connector of the AC end cable into the micro-inverter.

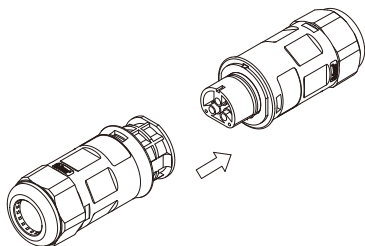

Figure Connect the AC connector



DANGER

To prevent electrical hazards, Make sure the micro-inverter system is disconnected from the home distribution network and the AC breaker is open.



CAUTION

There are no cables for the AC end cable in the package. The installation technician is responsible for selecting a kind of AC cable and connecting the micro-inverter system into the home distribution network correctly.

Step 5. Connect PV module

Connect the DC cables of the PV module to the DC connectors of micro-inverter.

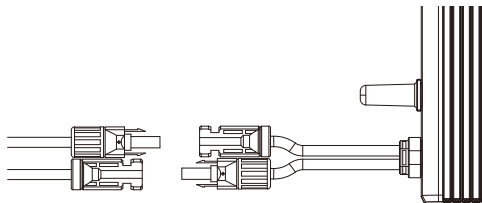

Figure Connect the DC connector



DANGER

When the PV module is exposed to light, it will supply a DC voltage to the micro-inverter.

**CAUTION**

If the DC cable is too short for installation, use a DC Extension Cable to connect two PV modules to TSOL-M1600 which are installed in one line.

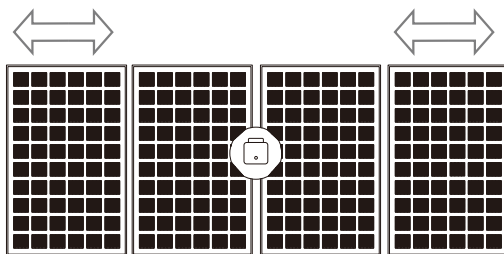

Figure TSOL-M1600 installed in one line

Step 6. Start the System

While installation is all finished, turn on the main utility-grid AC circuit breaker. Your system will start producing power after about a two-minute wait time.

The LED will flash green and red at start up. The definition of LED is shown as below.

LED	Indicates
Fast Flashing Green	Working normally and communicate with the monitoring system
Slow Flashing Green	Working normally but no communication with the monitoring system
Flashing Red	The power grid is abnormal
Solid Red	GFDI Fault

Maintenance Guide

Routine Maintenance

- Only authorized personnel are allowed to carry out the maintenance operations and are responsible for reporting any anomalies.
- Always use the personal protective equipment provided by the employer when carrying out maintenance.
- During normal operation, check that the environmental and logistic conditions are appropriate. Make sure that the conditions have not changed over time and that the equipment is not exposed to adverse weather conditions and has not been covered with foreign bodies.
- DO NOT use the equipment if any problems are found, and restore the normal conditions after the fault has been corrected.
- Conduct an annual inspection on various components, and clean the equipment with a vacuum cleaner or special brushes.
- Firmware version can be checked by using the monitoring system.
- Do not attempt to dismantle the Micro-inverter or make any internal repairs! In order to preserving the integrity of safety and insulation, the Micro inverters are not designed to allow internal repairs!
- Maintenance operations must be carried out with the equipment disconnected from the grid (AC power switch off) and the photovoltaic modules shaded or isolated, unless otherwise indicated.
- For cleaning, DO NOT use rags made of filamentary material or corrosive products that may corrode parts of the equipment or generate electro static charges.
- Avoid temporary repairs. All repairs should be carried out using only genuine spare parts.

Storage and Dismantling

- If the equipment is not used immediately or is stored for long periods, check whether it is correctly packed. The equipment must be stored in well-ventilated indoor areas that do not have characteristics that might damage the components of the equipment.
- Take a complete inspection when restarting after a long time or prolonged stop.
- Please dispose the equipment properly after scrapping, as component parts are potentially harmful to the environment, in accordance with the regulations in force in the country of installation.

Warranty

This Warranty is subject to the following conditions:

- The products must have been installed and correctly commissioned by an authorized and licensed installer. Proof may be required of correct commissioning of the Product (such as certificate of compliance). Claims for failures due to incorrect installation or commissioning are not covered under this Warranty.
- Where a Product or part thereof is replaced or repaired under this Warranty, the balance of the original Warranty period will apply. The replacement product or part (s) do not carry a new voluntary warranty.
- The product must have its original serial number and rating labels intact and readable.
- This Warranty does not extend to any product that has been completely or partially disassembled or modified, except where such disassembly is carried out by TSUNESS
- The terms of this Warranty cannot be amended except in writing by one of our authorized officers.
- There must have been a commissioning report signed by the end-user and the installer for product commissioning and handling instructions.

Exclusions

(a) TSUNESS makes no warranties, either expressed or implied, orally, or in writing, with respect to any other warranty coverage except those expressly stated in this limited Factory Warranty.

(b) The Factory Warranty does not cover damages that occur due to:

Transport damage;
Installation or commissioning through any person who is not an Authorized, Certified Dealer;

Failure to observe the user manual, maintenance regulations and intervals;
Modifications, changes, or attempted repairs, except as conducted by an Authorized Dealer;
Incorrect use or inappropriate operation;
Insufficient ventilation of the Covered Product;
Failure to observe the applicable safety regulations;
Force majeure.

(c) This factory warranty does not cover cosmetic defects which do not directly influence energy production, or degrade form, fit, and function.

(d) Claims that go beyond the scope of this limited Factory Warranty, in particular claims for compensation for direct or indirect damages arising from the defective device, for compensation for costs arising from disassembly and installation, or loss of profits, are expressly NOT covered by this Factory Warranty.

(e) In no event will TSUNESS Co., Ltd be held responsible or liable for any personal injuries resulting from the use of the system, or for any other damages, whether direct, indirect, incidental, or consequential; even if TSUNESS Co., Ltd has been advised of such damages.

Distributor Responsibility

In the event of an equipment failure or fault, it is the Distributor's responsibility to work directly with TSUNESS Service Centre in order to limit the return of non-faulty equipment. TSUNESS Service Centre will work with the Distributor to rectify the fault or fault message through telephone support or with direct PC links. Note: In order to qualify for further compensation and a replacement unit, the distributor/installer must first contact TSUNESS and fulfil the distributor's /installer's responsibilities under instruction.

Miscellaneous

This Warranty shall form part of the purchase contract in respect of the Product between us and the end-user and shall be complied with by both parties.

Contact

If you have technical problems about our products, contact the TSUNESS Service line. We need the following information in order to provide you with the necessary assistance:

Inverter type

Serial number of the inverter

Descriptions of the problem

Type and number of PV modules connected

Optional equipment

TSUNESS Co., Ltd

Tel: +86-512-6618 6028

E-mail: sales@tsun-ess.com | www.tsun-ess.com

Add: Building E1, No. 555, Chuangye Road, Dayun Town, Jiashan Country,
Jiaxing City, Zhejiang Province, China



TSUNESS Co., Ltd

 www.tsun-ess.com

 sales@tsun-ess.com

 Building E1, No. 555, Chuangye Road, Dayun
Town, Jiashan Country, Jiaxing City, Zhejiang Province, China