



Art.-Nr.: 500.67
PJZ 07/17



ZigBee Remote Control

1x

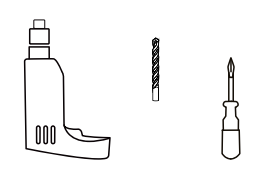
incl.

A

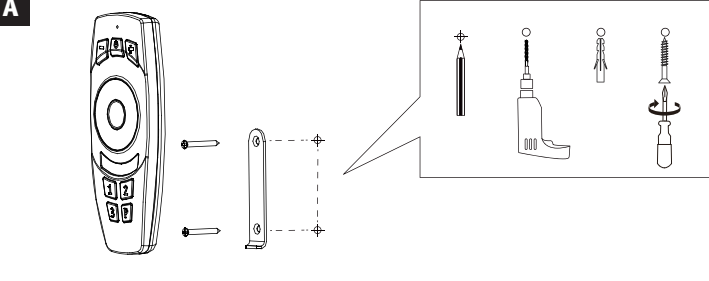

B

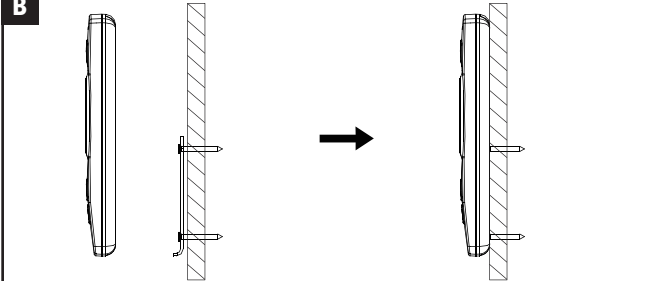

C

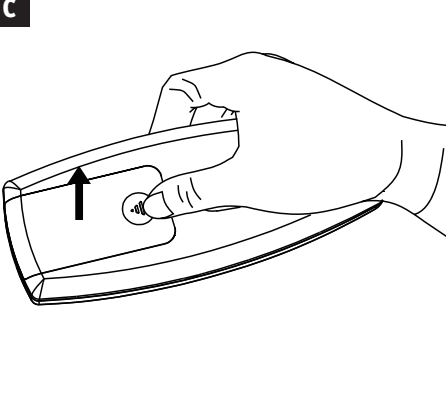

D

Not incl.

2xAAA/1.5V

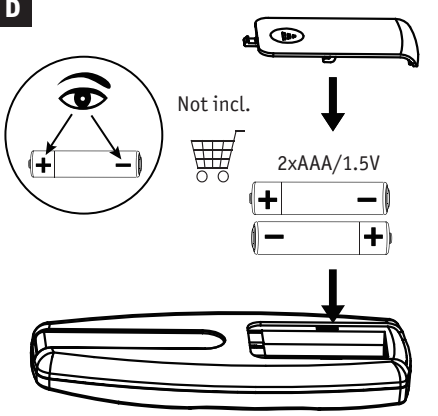

E

"CLICK"

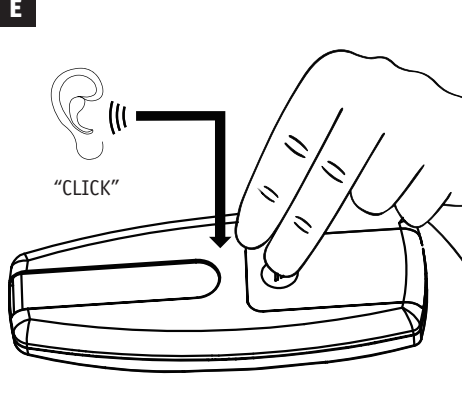

F

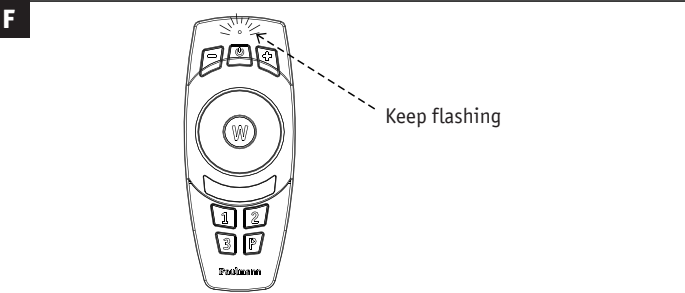







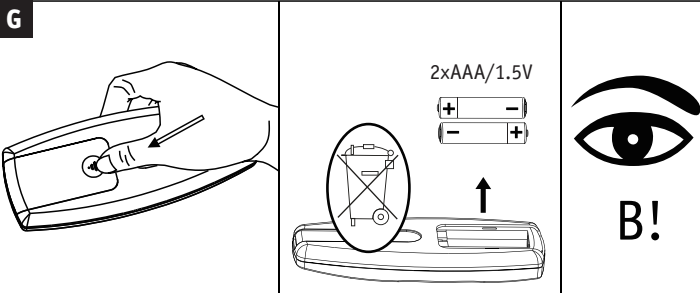

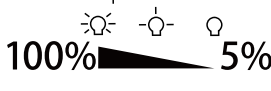

Keep flashing

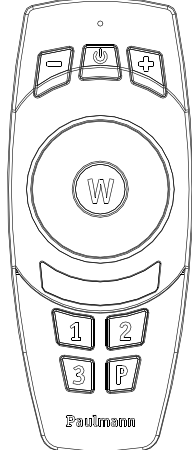
G

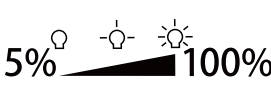
2xAAA/1.5V



B!

	100%  5%		ON/OFF	
	5%  100%		2700K	
	RGB		R-G-B-Color Loop	
	6500K \longleftrightarrow 2700K		Group	

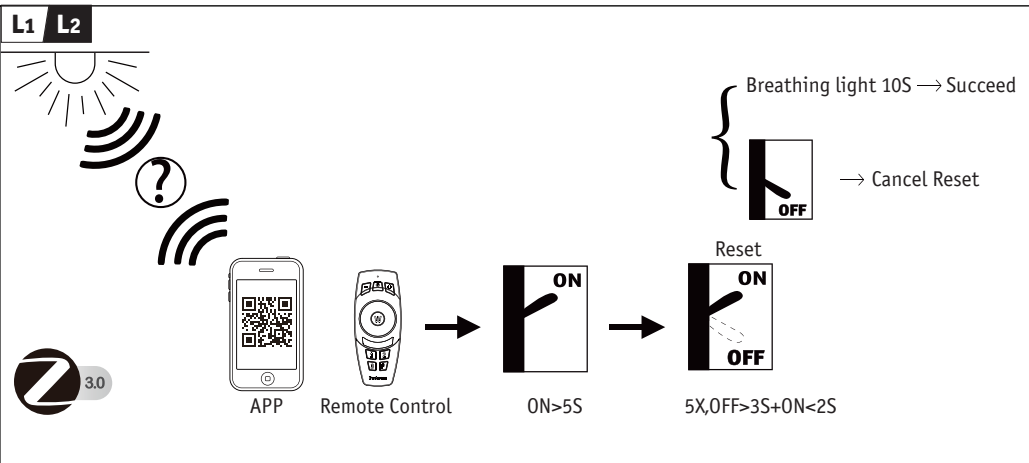
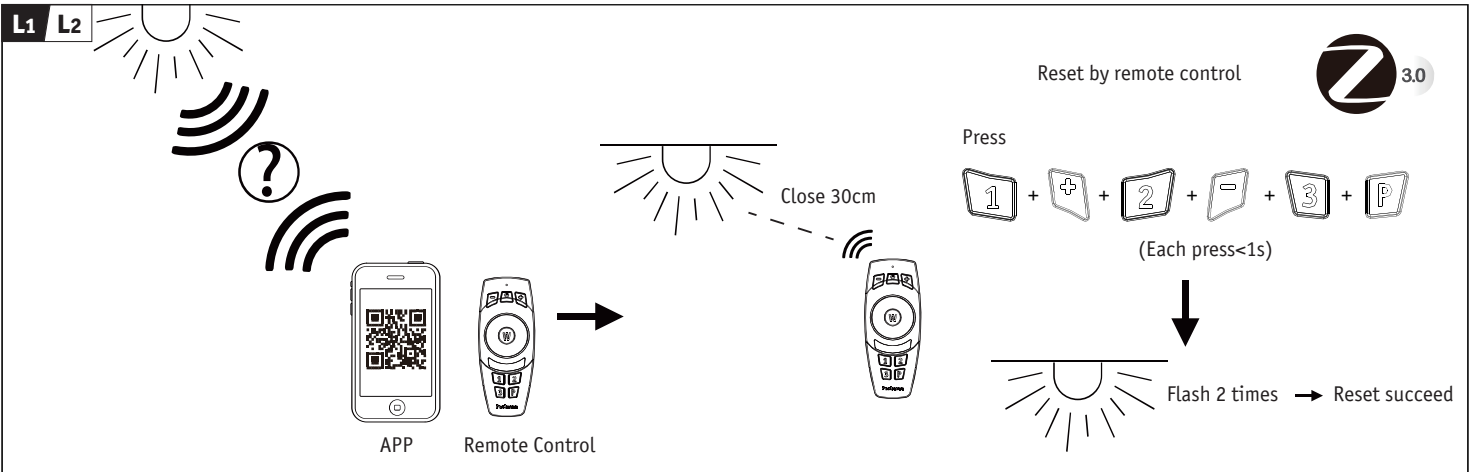
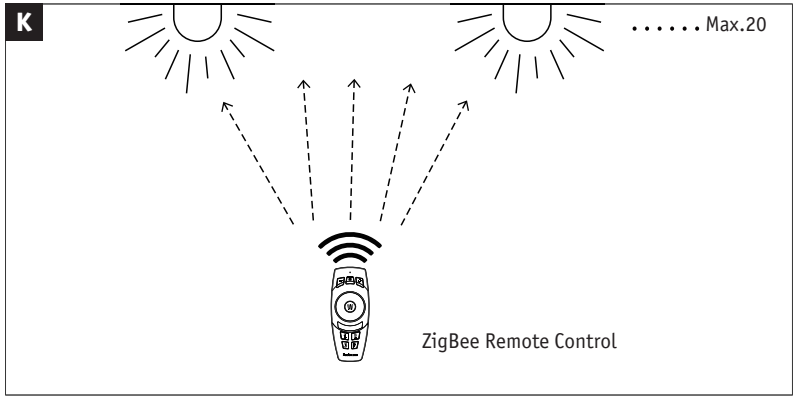
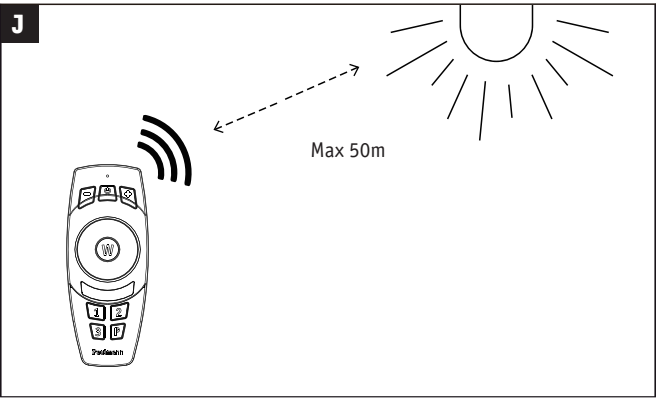
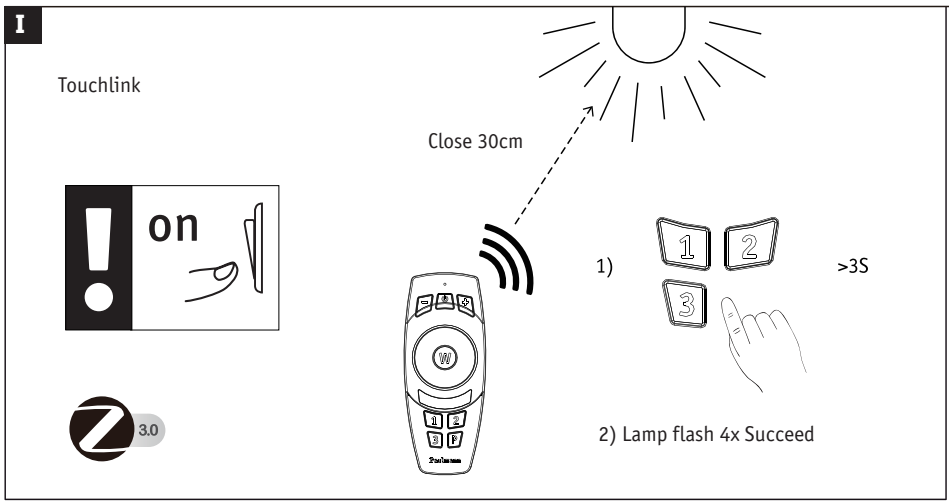
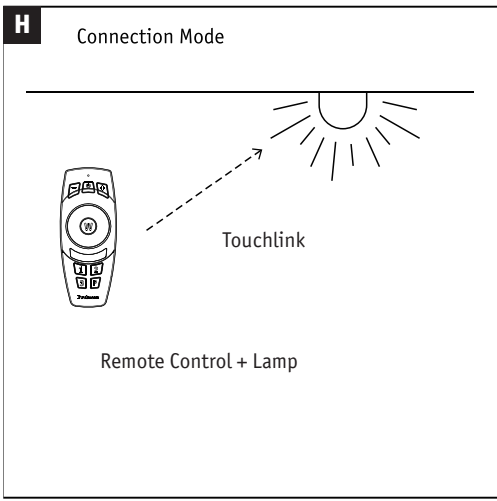

Zugelassen für den Betrieb in allen Ländern der EU / Approved for operating in all European countries

CE: Konform mit / in accordance with / conformement a 2014/30/EU, 2014/53/EU <http://www.paulmann.com/de/de/b2b-haendler-log-in.html>

2,4 GHz - 2,4835 GHz

! NO

doesn't apply for the geographical area within a radius of 20km from the centre on "Ny Alesund"

Hiermit erklärt Paulmann Licht, dass der Funkanlagentyp [500.67] der Richtlinie 2014/53/EU entspricht. Der vollständige Text der EU-Konformitätserklärung ist unter der folgenden Internetadresse verfügbar: " www.paulmann.com/ce Funk-Frequenz [2,4 GHz - 2,4835 GHz] Abgestrahlte Energie [10mW]