

12.61/62

INTERRUTTORE ORARIO DIGITALE GIORNALIERO/SETTIMANALE

Programmazione facilitata tramite App "FINDER TOOLBOX" con tecnologia NFC, scaricabile da Google Play™

EN 60669-1 / EN 60669-2-1	
	12.6x8.230.0000 U _N 110...230 V AC (50/60 Hz) / DC U _{min} - U _{max} 88 V - 253 V (AC/DC) P 2.8 VA (50 Hz) / 0.9 W
	12.61.0.024.0000 U _N 24 (12...24) V AC (50/60 Hz) / DC U _{min} - U _{max} 10 V - 30 V (AC/DC) P 2.2 VA / 1.2 W
	1 CO (SPDT) (12.61) 2 CO (DPDT) (12.62) 16 A 250 V AC
	AC1 4000 VA AC15 (230 V AC) 750 VA
	(230 V) 2000 W
	(230 V) 750 W
	CFL-LED (230 V) 400 W
	(-20...+50)°C
IP20	

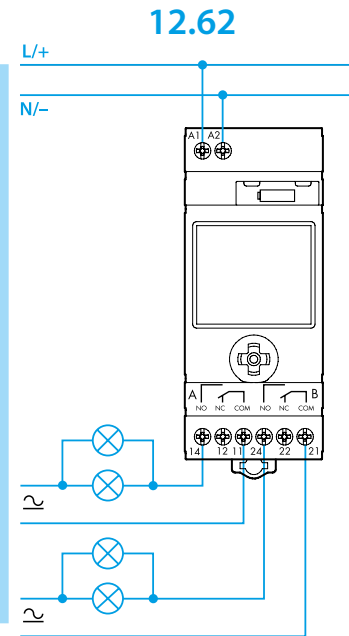
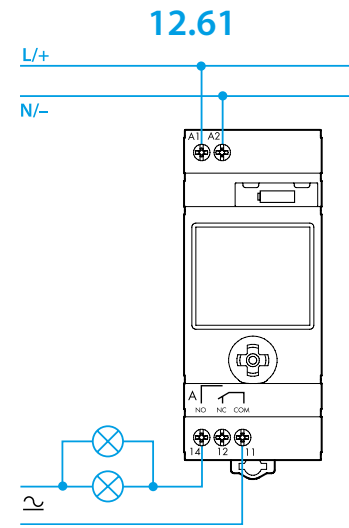
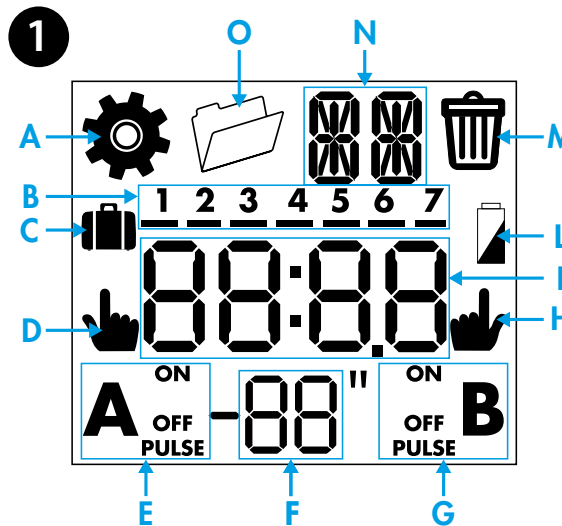

- DESCRIZIONE DISPLAY**
 - A Menù Impostazione prodotto
 - B Giorni della settimana (1=Lun...7=Dom)
 - C Programma Vacanze attivo
 - D Manuale PERMANENTE canale A attivo
 - E Funzioni Canale A (ON, OFF, Impulso)
 - F Giorno - secondi/minuti
 - G Funzioni Canale B (ON, OFF, Impulso) (solo 12.62)
 - H Manuale PERMANENTE canale B attivo (solo 12.62)
 - I Ore, anno, giorno, mese, ore, minuti, ora legale ON/OFF, Programma Vacanze (Inizio: giorno/mese. Fine: giorno/mese), PIN ON/OFF, End (uscita dal menù)
 - L Prodotto non alimentato (funzionamento tramite batteria) - batteria scarica (Prodotto alimentato)
 - M Cancellazione
 - N Numero Programma (max 50) - Y(anno), D(giorno), M(mese), H(ore), M(minuti), Ora legale ON/OFF (EU=Europa - BR=Brasile - AU=Australia) Programma Vacanze (Inizio: giorno/mese. Fine: giorno/mese)
 - O Menù Programmazione

- IMPOSTAZIONI PRODOTTO (esempio)**
 - 2a Impostare: anno, giorno, mese, ore, minuti, EU (Ora legale)
 - 2b Programma vacanze (Inizio: giorno/mese. Fine: giorno/mese), PIN, End (uscita dal menù)

- PROGRAMMAZIONI (esempi)**
 - 3a Funzione ON - OFF (6:25 ON - 19:15 OFF, Lun, Mer, Ven, Dom)
 - 3b Funzione IMPULSO (11:00 impulso 5 s, Lun, Mer, Ven)

- MODALITA MANUALE**
 - 4a Manuale ON/OFF canale A
 - 4b Manuale ON/OFF canale B (solo 12.62)
 - 4c Manuale Permanente ON/OFF canale A
 - 4d Manuale Permanente ON/OFF canale B (solo 12.62)

- CANCELLAZIONE di tutti i programmi**
- CANCELLAZIONE del singolo programma**

NOTE

- Sostituzione batteria: BATTERIA CR 2032 (LiMnO₂) 3V, 230mAh. Prodotto esente Art.11 Dir. 2006/66/CE.
- Display retroilluminato (solo quando il prodotto è alimentato)
- Intervallo minimo di programmazione: 1 secondo (funzione impulso)

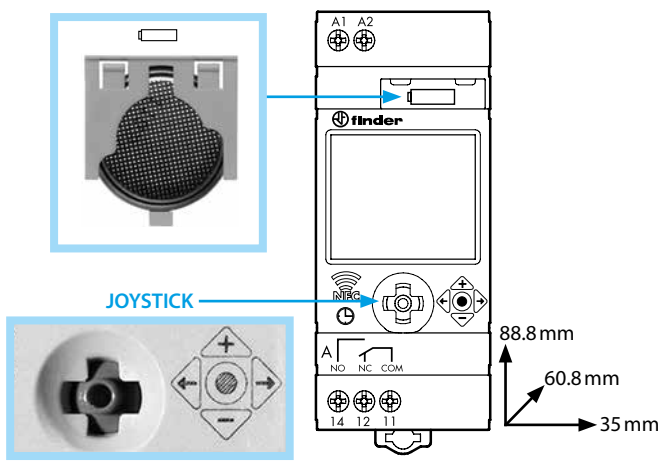

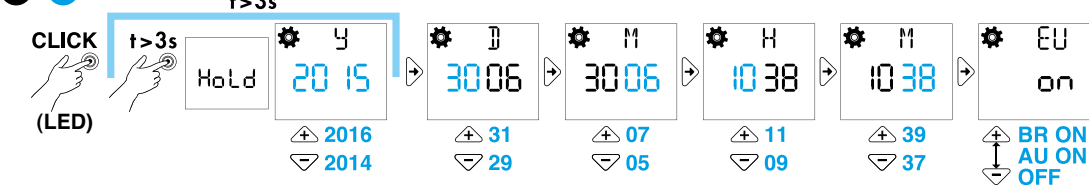

2 2a

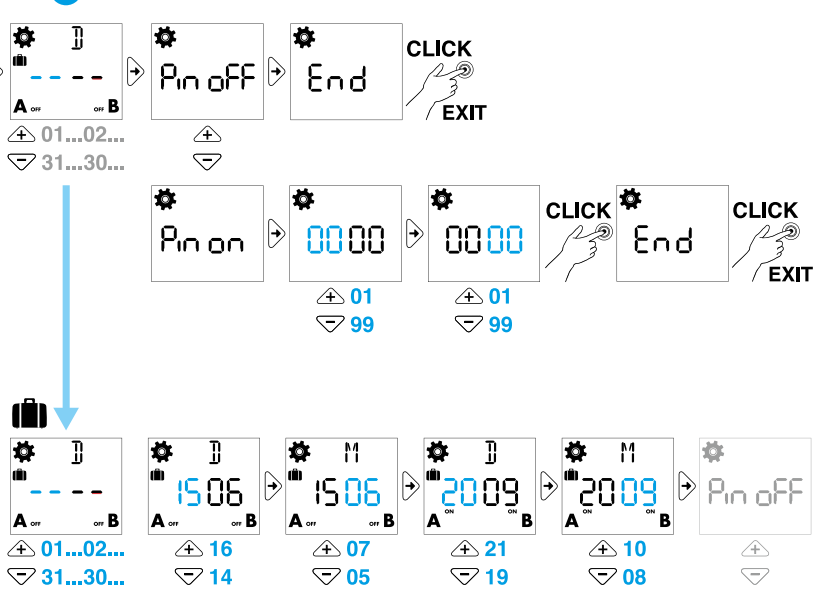

2b

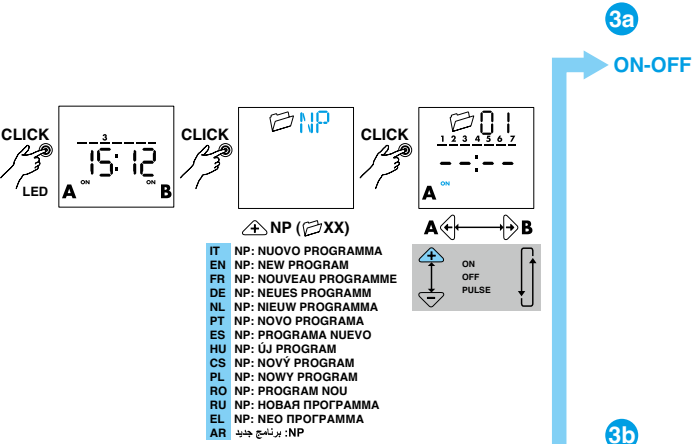

3



3a

ON-OFF

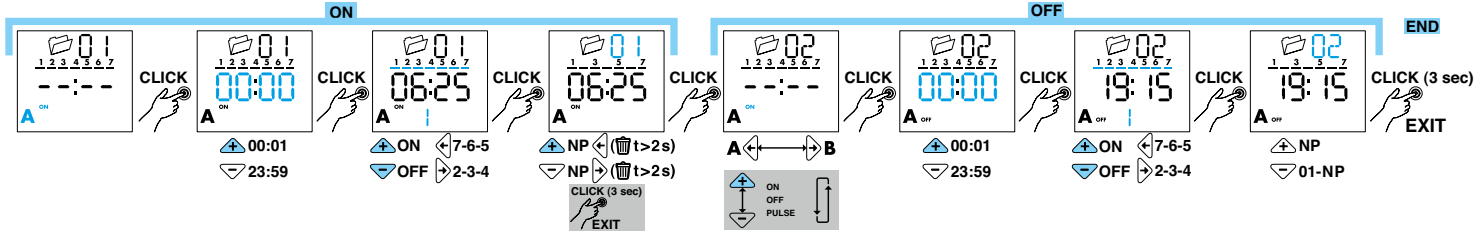

3b

PULSE

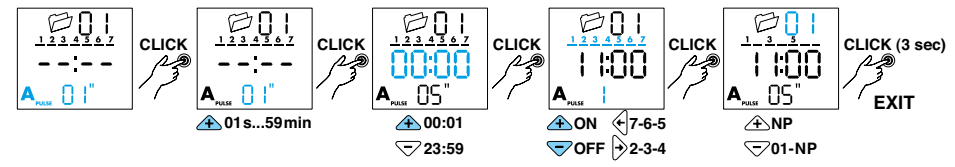

4

4a



4b

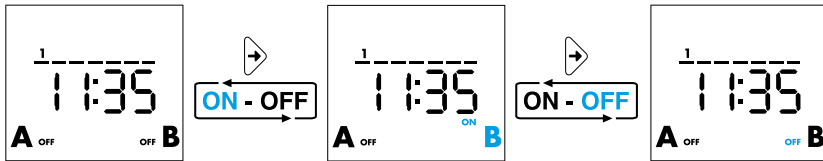

4c



4d



5

IT CANCELLAZIONE DI TUTTI I PROGRAMMI
 EN DELETION OF ALL PROGRAM
 FR SUPPRESSION DE TOUS LES PROGRAMMES
 DE LÖSCHEN ALLER PROGRAMME
 NL WISSEN VAN ALLE PROGRAMMA'S
 PT ELIMINAÇÃO DE TODO PROGRAMA
 ES BORRAR TODOS LOS PROGRAMAS

HU AZ ÖSSZES PROGRAM TÖRLÉSE
 CS ODSTRANĚNÍ VŠECH PROGRAMU
 PL USUNIĘCIE WSZYSTKICH PROGRAMÓW
 RO ȘTERGE TOATE PROGRAMELE
 RU УДАЛЕНИЕ ВСЕХ ПРОГРАММ
 EL ΔΙΑΓΡΑΦΗ ΌΛΩΝ ΤΩΝ ΠΡΟΓΡΑΜΜΑΤΩΝ
 AR محو كل البرامج

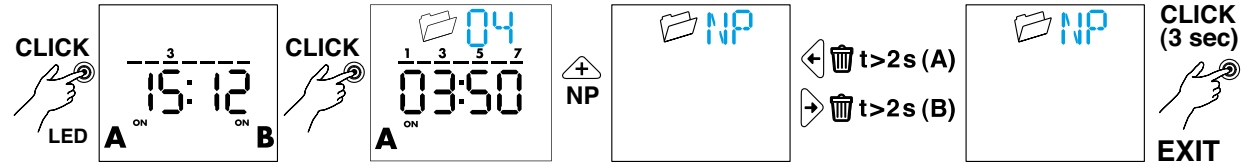

6

IT CANCELLAZIONE DI UN SINGOLO PROGRAMMA
 EN DELETION OF SINGLE PROGRAM
 FR SUPPRESSION D'UN SEUL PROGRAMME
 DE LÖSCHEN EINES PROGRAMMES
 NL WISSEN VAN EEN ENKEL PROGRAMMA
 PT ELIMINAÇÃO DE PROGRAMA INDIVIDUAL
 ES BORRAR UN PROGRAMA

HU EGY PROGRAM TÖRLÉSE
 CS ODSTRANĚNÍ JEDNOHO PROGRAMU
 PL USUNIĘCIE JEDNEGO PROGRAMU
 RO ȘTERGE UN SINGUR PROGRAM
 RU УДАЛЕНИЕ ОДНОЙ ПРОГРАММЫ
 EL ΔΙΑΓΡΑΦΗ ΕΝΟΣ ΠΡΟΓΡΑΜΜΑΤΟΣ
 AR محو برنامج واحد

